

www.americanprod.com Email: bids@americanprod.com

Fax: 813-925-1414

Phone: 813-925-0144

STANDARD FEATURES

Narrow Stile Door 2" Vertical Stile, 2-1/2" Top Rail and 3-1/2" Bottom Rail
 Medium Stile Door 3-1/2" Vertical Stile, 3-1/2" Top Rail and 5" Bottom Rail (Option Pricing)
 Wide Stile Door 5" Vertical Stile, 5" Top Rail and 6-1/2" Bottom Rail (Option Pricing)
 Doors are 1-3/4" Thick
 Thru Rod / Welded Construction
 Offset Pivots / Butt Hinges / Center Pivots / Continuous Geared Hinges - Priced Per Section
 Surface Mounted or Concealed Closers - Priced Separately
 MS Locks
 10" Pull/Push Bar
 Stops for 1/4", 1/2" or 1" Infill

AVAILABLE OPTIONS

Anodized Finish in Either Clear or Bronze
 70% Two-Coat Kynar Finish - Pricing applies to standard colors only
 Powder Coated Finish in Hundreds of Colors
 Stainless Steel Clad

OPTIONAL FEATURES

Custom Push/Pulls in Many Different Finishes
 Optional Bottom Rails
 Optional Cross Rails
 Exit Devices

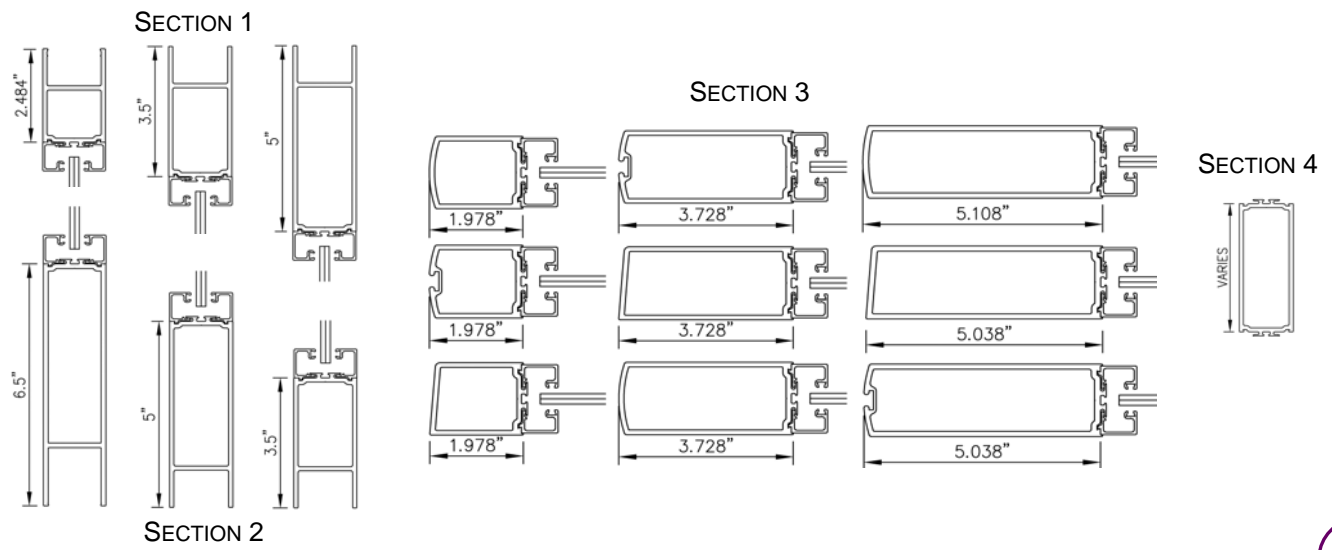
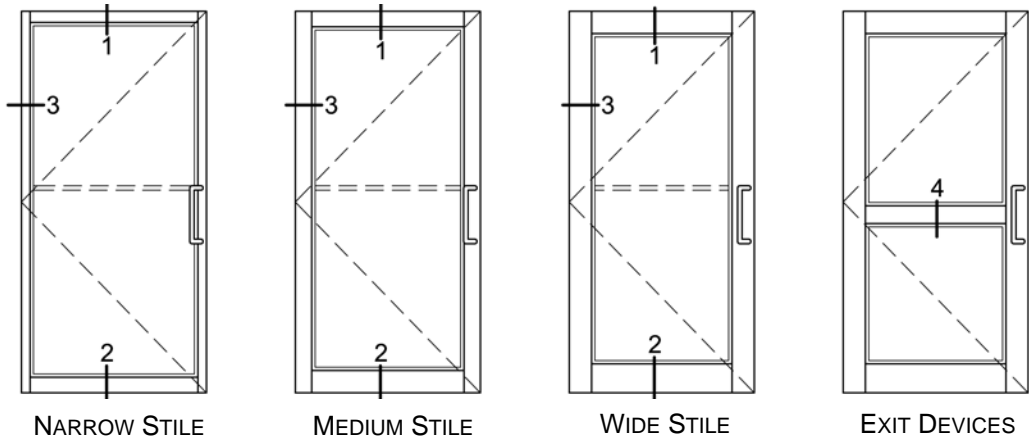

NOTES

API AMERICAN PRODUCTS, INC.	API AMERICAN PRODUCTS, INC.	API AMERICAN PRODUCTS, INC.	API AMERICAN PRODUCTS, INC.
API AMERICAN PRODUCTS, INC.	API AMERICAN PRODUCTS, INC.	API AMERICAN PRODUCTS, INC.	API AMERICAN PRODUCTS, INC.
API AMERICAN PRODUCTS, INC.	API AMERICAN PRODUCTS, INC.	API AMERICAN PRODUCTS, INC.	API AMERICAN PRODUCTS, INC.
API AMERICAN PRODUCTS, INC.	API AMERICAN PRODUCTS, INC.	API AMERICAN PRODUCTS, INC.	API AMERICAN PRODUCTS, INC.
API AMERICAN PRODUCTS, INC.	API AMERICAN PRODUCTS, INC.	API AMERICAN PRODUCTS, INC.	API AMERICAN PRODUCTS, INC.
API AMERICAN PRODUCTS, INC.	API AMERICAN PRODUCTS, INC.	API AMERICAN PRODUCTS, INC.	API AMERICAN PRODUCTS, INC.

Narrow Stile with 2 Butt Hinges Storefront Doors +/- 30 PSF

www.americanprod.com Email: bids@americanprod.com

Phone: 813-925-0144 Fax: 813-925-1414

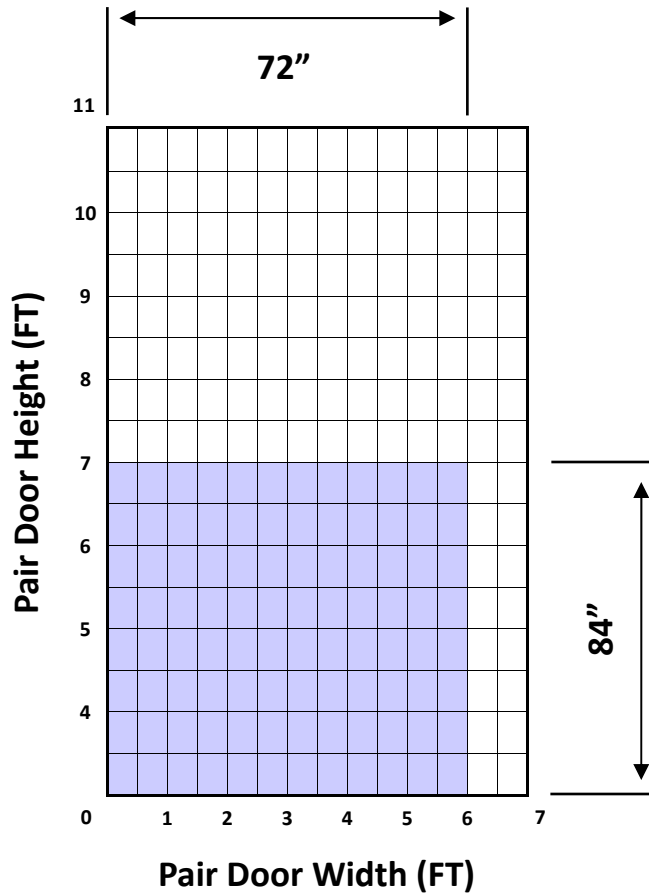
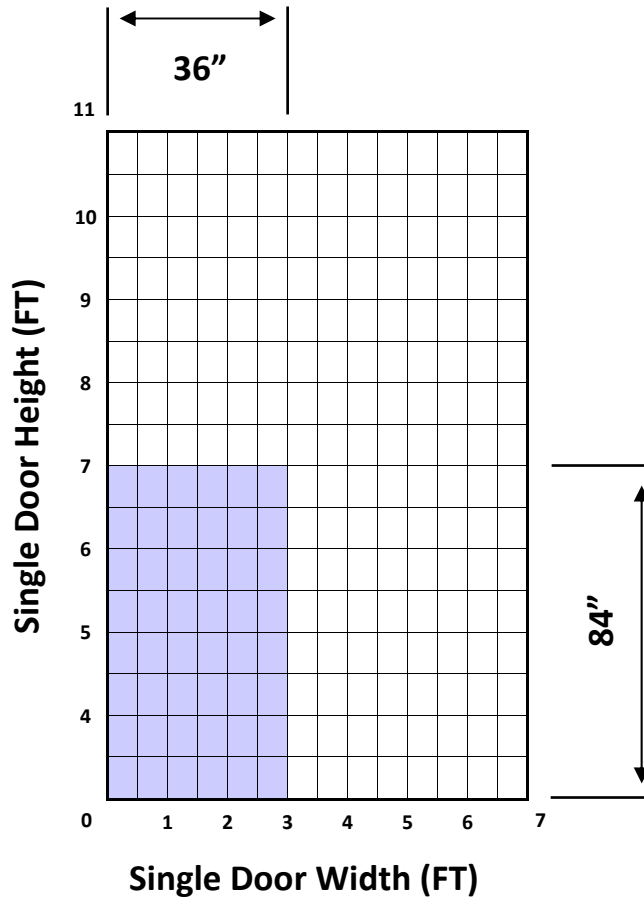

The Design Pressure is less than or equal to 30 PSF Positive and 30 PSF Negative.



Price Includes:

- Narrow Stile Door with Top and Bottom Offset Pivots
- 1/4" Square Glass Stop
- 3-1/2" Bottom Rail
- Adams Rite MS 1850 Deadbolt Lock
- Cylinder Exterior , Thumb Turn Interior
- Manual Flush Bolts on Pairs
- 1" x 10" Back to Back Pull / Push Bar
- All Closers Sold Separately

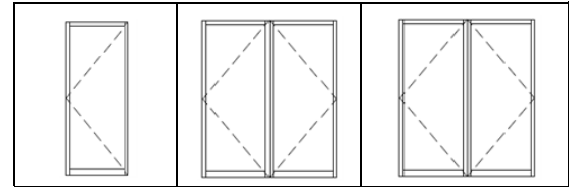

	Single 3'0" x 7'0"	Pair 6'0" x 7'0"	Pair 6'0" x 8'0"
Clear	\$766.80	\$1,404.00	\$1,758.24
Bronze	\$812.70	\$1,498.50	\$1,852.74
Two-Coat Kynar	\$807.30	\$1,487.70	\$1,841.94
Powder Coat	\$810.00	\$1,490.40	\$1,844.64
Brushed SS Clad	Quote	Quote	Quote
Polished SS clad	Quote	Quote	Quote

www.americanprod.com Email: bids@americanprod.com

Phone: 813-925-0144 Fax: 813-925-1414

Door Hardware Options (Per Leaf)		
Intermediate Offset Pivot	ADD	\$177.12
Exit Indicator	ADD	\$100.44
3 Point Locking on Pairs	ADD	\$72.90
MS 1850 Hook Bolt	ADD	N/C
Sub Vestibule Conversion (Single) (No Lock)	Deduct	-\$50.00
Sub Vestibule Conversion (Pair) (No Lock)	Deduct	-\$65.60
Concealed Rod Exit	ADD	\$359.64
Prep for Customer Supplied Hardware	ADD	Quote

Door Options (Per Leaf)		
Medium Stile Door with Standard 5" Bottom Rail	ADD	\$161.00
Wide Stile Door with Standard 6-1/2" Bottom Rail	ADD	\$300.00
Special Door Height up to 8'	ADD	\$177.12
Special Door Width up to 4' (Add to 3' Door)	ADD	\$240.00
6-1/2" Bottom Rail	ADD	\$15.88
10" Bottom Rail	ADD	\$51.52
12" Bottom Rail (Stacked Construction with Kick Plate)	ADD	\$192.78
Door Sweep with Snap Cover Up 42"	ADD	\$25.06
1" Glass Stop in Lieu of 1/4" Stop	ADD	N/C
For 4" Crossrail	ADD	\$115.43
For 2" Crossrail	ADD	\$109.73
Custom Crossrail	ADD	Quote

Please call for special prices on items not listed above









Price Includes:

2" x 4-1/2" Frames

4" Threshold

Frames with Transom Include:

- Transom Bar
- Stops
- Gasket

						
	Single 3'0 x 7'0	Single 3'0 x 7'0	Pair 6'0 x 7'0	Pair 6'0 x 7'0	Pair 6'0 x 8'0	Pair 6'0 x 8'0
Clear	\$211.20	\$441.60	\$243.20	\$518.40	\$343.20	\$618.40
Bronze	\$252.80	\$537.60	\$294.40	\$624.00	\$394.40	\$724.00
Two-Coat Kynar	\$249.60	\$531.20	\$291.20	\$620.80	\$391.20	\$720.80
Powder Coat	\$227.20	\$502.40	\$265.60	\$585.60	\$365.60	\$685.60
Brushed SS Clad	Quote	Quote	Quote	Quote	Quote	Quote
Polished SS clad	Quote	Quote	Quote	Quote	Quote	Quote

Frame Hardware Options

Intermediate Offset Pivot	ADD	\$24.00
3 Point Locking on Pairs	ADD	N/C
MS 1850 Hook Bolt	ADD	N/C
Sub Vestibule Conversion (Single) (No Threshold)	Deduct	-\$8.64
Sub Vestibule Conversion (Pair) (No Threshold)	Deduct	-\$17.28
Concealed Rod Exit	ADD	N/C
Prep for Customer Supplied Hardware	ADD	Quote

Frame Options

Special Frame Height up to 8' Without Transom	ADD	\$100.00
Special Frame Height up to 10'3" With Transom	ADD	\$80.00
Special Frame Width up to 4' (Add to 3' Frame)	ADD	\$80.00

Please call for special prices on items not listed above

www.americanprod.com Email: bids@americanprod.com

Phone: 813-925-0144 Fax: 813-925-1414



STANDARD LOCKING DOORS

Butt Hinges Doors Only

DRAFT



Price Includes:

- Narrow Stile Door with One Pair Standard Butt Hinges
- 1/4" Square Glass Stop
- 3-1/2" Bottom Rail
- Adams Rite MS 1850 Deadbolt Lock
- Cylinder Exterior , Thumb Turn Interior
- Manual Flush Bolts on Pairs
- 1" x 10" Back to Back Pull / Push Bar
- All Closers Sold Separately

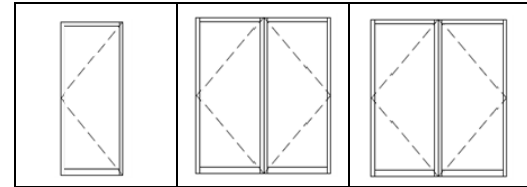

	Single 3'0 x 7'0	Pair 6'0 x 7'0	Pair 6'0 x 8'0
Clear	\$723.60	\$1,323.00	\$1,677.24
Bronze	\$769.50	\$1,414.80	\$1,769.04
Two-Coat Kynar	\$766.80	\$1,406.70	\$1,760.94
Powder Coat	\$766.80	\$1,409.40	\$1,763.64
Brushed SS Clad	Quote	Quote	Quote
Polished SS clad	Quote	Quote	Quote

www.americanprod.com Email: bids@americanprod.com

Phone: 813-925-0144 Fax: 813-925-1414

Door Hardware Options (Per Leaf)		
Intermediate Butt Hinge	ADD	\$38.84
Exit Indicator	ADD	\$100.44
Automatic 3 Point Locking on Pairs	ADD	\$72.90
MS 1850 Hook Bolt	ADD	N/C
Sub Vestibule Conversion (Single) (No Lock)	Deduct	-\$50.00
Sub Vestibule Conversion (Pair) (No Lock)	Deduct	-\$65.60
Concealed Rod Exit	ADD	\$359.64
Prep for Customer Supplied Hardware	ADD	Quote

Door Options (Per Leaf)		
Medium Stile Door with Standard 5" Bottom Rail	ADD	\$161.00
Wide Stile Door with Standard 6-1/2" Bottom Rail	ADD	\$300.00
Special Door Height up to 8'	ADD	\$177.12
Special Door Width up to 4' (Add to 3' Door)	ADD	\$240.00
6-1/2" Bottom Rail	ADD	\$15.88
10" Bottom Rail	ADD	\$51.52
12" Bottom Rail (Stacked Construction with Kick Plate)	ADD	\$192.78
Door Sweep with Snap Cover Up 42"	ADD	\$25.06
1" Glass Stop in Lieu of 1/4" Stop	ADD	N/C
For 4" Crossrail	ADD	\$115.43
For 2" Crossrail	ADD	\$109.73
Custom Crossrail	ADD	Quote

Please call for special prices on items not listed above









Price Includes:

2" x 4-1/2" Frames

4" Threshold

Frames with Transom Include:

- Transom Bar
- Stops
- Gasket

						
	Single 3'0 x 7'0	Single 3'0 x 7'0	Pair 6'0 x 7'0	Pair 6'0 x 7'0	Pair 6'0 x 8'0	Pair 6'0 x 8'0
Clear	\$211.20	\$441.60	\$256.00	\$518.40	\$356.00	\$618.40
Bronze	\$252.80	\$537.60	\$300.80	\$624.00	\$400.80	\$724.00
Two-Coat Kynar	\$249.60	\$531.20	\$300.80	\$620.80	\$400.80	\$720.80
Powder Coat	\$227.20	\$502.40	\$275.20	\$585.60	\$375.20	\$685.60
Brushed SS Clad	Quote	Quote	Quote	Quote	Quote	Quote
Polished SS clad	Quote	Quote	Quote	Quote	Quote	Quote

Frame Hardware Options

Intermediate Butt Hinge	ADD	\$23.16
3 Point Locking on Pairs	ADD	N/C
MS 1850 Hook Bolt	ADD	N/C
Sub Vestibule Conversion (Single) (No Threshold)	Deduct	-\$8.64
Sub Vestibule Conversion (Pair) (No Threshold)	Deduct	-\$17.28
Concealed Rod Exit	ADD	N/C
Prep for Customer Supplied Hardware	ADD	Quote

Frame Options

Special Frame Height up to 8' Without Transom	ADD	\$100.00
Special Frame Height up to 10'3" With Transom	ADD	\$80.00
Special Frame Width up to 4' (Add to 3' Frame)	ADD	\$80.00

Please call for special prices on items not listed above

www.americanprod.com Email: bids@americanprod.com

Phone: 813-925-0144 Fax: 813-925-1414



STANDARD LOCKING DOORS

Center Pivot Doors Only

DRAFT



Price Includes:

- Narrow Stile Door with Top and Bottom Center Pivots
- 1/4" Square Glass Stop
- 3-1/2" Bottom Rail
- Adams Rite MS 1850 Deadbolt Lock
- Cylinder Exterior , Thumb Turn Interior
- Manual Flush Bolts on Pairs
- 1" x 10" Back to Back Pull / Push Bar
- All Closers Sold Separately

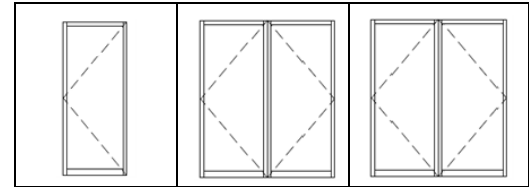

	Single 3'0 x 7'0	Pair 6'0 x 7'0	Pair 6'0 x 8'0
Clear	\$847.80	\$1,566.00	\$1,920.24
Bronze	\$893.70	\$1,660.50	\$2,014.74
Two-Coat Kynar	\$891.00	\$1,652.40	\$2,006.64
Powder Coat	\$891.00	\$1,652.40	\$2,006.64
Brushed SS Clad	Quote	Quote	Quote
Polished SS clad	Quote	Quote	Quote

www.americanprod.com Email: bids@americanprod.com

Phone: 813-925-0144 Fax: 813-925-1414

Door Hardware Options (Per Leaf)		
Exit Indicator	ADD	\$100.44
Automatic 3 Point Locking on Pairs	ADD	\$72.90
MS 1850 Hook Bolt	ADD	N/C
Sub Vestibule Conversion (Single) (No Lock)	Deduct	-\$50.00
Sub Vestibule Conversion (Pair) (No Lock)	Deduct	-\$65.60
Concealed Rod Exit	ADD	\$359.64
Prep for Customer Supplied Hardware	ADD	Quote
Door Options (Per Leaf)		
Medium Stile Door with Standard 5" Bottom Rail	ADD	\$161.00
Wide Stile Door with Standard 6-1/2" Bottom Rail	ADD	\$300.00
Special Door Height up to 8'	ADD	\$177.12
Special Door Width up to 4' (Add to 3' Door)	ADD	\$240.00
6-1/2" Bottom Rail	ADD	\$15.88
10" Bottom Rail	ADD	\$51.52
12" Bottom Rail (Stacked Construction with Kick Plate)	ADD	\$192.78
Door Sweep with Snap Cover	ADD	\$25.06
1" Glass Stop in Lieu of 1/4" Stop Up 42"	ADD	N/C
For 4" Crossrail	ADD	\$115.43
For 2" Crossrail	ADD	\$109.73
Custom Crossrail	ADD	Quote
Please call for special prices on items not listed above		









Price Includes:

2" x 4-1/2" Frames

4" Threshold

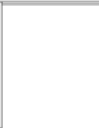
Frames with Transom Include:

- Transom Bar
- Stops
- Gasket

						
	Single 3'0 x 7'0	Single 3'0 x 7'0	Pair 6'0 x 7'0	Pair 6'0 x 7'0	Pair 6'0 x 8'0	Pair 6'0 x 8'0
Clear	\$259.20	\$470.40	\$368.00	\$601.60	\$468.00	\$701.60
Bronze	\$310.40	\$572.80	\$425.60	\$720.00	\$525.60	\$820.00
Two-Coat Kynar	\$307.20	\$569.60	\$452.60	\$716.80	\$552.60	\$816.80
Powder Coat	\$281.60	\$531.20	\$393.60	\$672.00	\$493.60	\$772.00
Brushed SS Clad	Quote	Quote	Quote	Quote	Quote	Quote
Polished SS clad	Quote	Quote	Quote	Quote	Quote	Quote

Frame Hardware Options

3 Point Locking on Pairs	ADD	N/C
MS 1850 Hook Bolt	ADD	N/C
Sub Vestibule Conversion (Single) (No Threshold)	Deduct	-\$8.64
Sub Vestibule Conversion (Pair) (No Threshold)	Deduct	-\$17.28
Concealed Rod Exit	ADD	N/C
Prep for Customer Supplied Hardware	ADD	Quote

Frame Options

Special Frame Height up to 8' Without Transom	ADD	\$100.00
Special Frame Height up to 10'3" With Transom	ADD	\$80.00
Special Frame Width up to 4' (Add to 3' Frame)	ADD	\$80.00

Please call for special prices on items not listed above

www.americanprod.com Email: bids@americanprod.com

Phone: 813-925-0144 Fax: 813-925-1414



STANDARD LOCKING DOORS

Continuous Geared Hinges Doors Only

Price Includes:

- Narrow Stile Door with Gear Hinge
- 1/4" Square Glass Stop
- 3-1/2" Bottom Rail
- Adams Rite MS 1850 Deadbolt Lock
- Cylinder Exterior , Thumb Turn Interior
- Manual Flush Bolts on Pairs
- 1" x 10" Back to Back Pull / Push Bar
- All Closers Sold Separately

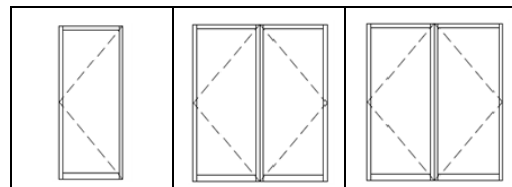

	Single 3'0 x 7'0	Pair 6'0 x 7'0	Pair 6'0 x 8'0
Clear	\$936.90	\$1,746.90	\$2,101.14
Bronze	\$972.00	\$1,841.40	\$2,195.64
Two-Coat Kynar	\$977.40	\$1,822.50	\$2,176.74
Powder Coat	\$980.10	\$1,833.30	\$2,187.54
Brushed SS Clad	Quote	Quote	Quote
Polished SS clad	Quote	Quote	Quote

Door Hardware Options (Per Leaf)		
Exit Indicator	ADD	\$100.44
Automatic 3 Point Locking on Pairs	ADD	\$72.90
MS 1850 Hook Bolt	ADD	N/C
Sub Vestibule Conversion (Single) (No Lock)	Deduct	-\$50.00
Sub Vestibule Conversion (Pair) (No Lock)	Deduct	-\$65.60
Concealed Rod Exit	ADD	\$359.64
Prep for Customer Supplied Hardware	ADD	Quote
Door Options (Per Leaf)		
Medium Stile Door with Standard 5" Bottom Rail	ADD	\$161.00
Wide Stile Door with Standard 6-1/2" Bottom Rail	ADD	\$300.00
Special Door Height up to 8'	ADD	\$177.12
Special Door Width up to 4' (Add to 3' Door)	ADD	\$240.00
6-1/2" Bottom Rail	ADD	\$15.88
10" Bottom Rail	ADD	\$51.52
12" Bottom Rail (Stacked Construction with Kick Plate)	ADD	\$192.78
Door Sweep with Snap Cover Up 42"	ADD	\$25.06
1" Glass Stop in Lieu of 1/4" Stop	ADD	N/C
For 4" Crossrail	ADD	\$115.43
For 2" Crossrail	ADD	\$109.73
Custom Crossrail	ADD	Quote
Please call for special prices on items not listed above		

www.americanprod.com Email: bids@americanprod.com

Phone: 813-925-0144 Fax: 813-925-1414



Price Includes:

2" x 4-1/2" Frames

4" Threshold

Frames with Transom Include:

- Transom Bar
- Stops
- Gasket

	Single 3'0 x 7'0	Single 3'0 x 7'0	Pair 6'0 x 7'0	Pair 6'0 x 7'0	Pair 6'0 x 8'0	Pair 6'0 x 8'0
Clear	\$201.60	\$435.20	\$236.80	\$508.80	\$336.80	\$608.80
Bronze	\$259.20	\$544.00	\$284.80	\$617.60	\$384.80	\$717.60
Two-Coat Kynar	\$243.20	\$518.40	\$284.80	\$611.20	\$384.80	\$711.20
Powder Coat	\$220.80	\$492.80	\$259.20	\$576.00	\$359.20	\$676.00
Brushed SS Clad	Quote	Quote	Quote	Quote	Quote	Quote
Polished SS clad	Quote	Quote	Quote	Quote	Quote	Quote

Frame Hardware Options

3 Point Locking on Pairs	ADD	N/C
MS 1850 Hook Bolt	ADD	N/C
Sub Vestibule Conversion (Single) (No Threshold)	Deduct	-\$8.64
Sub Vestibule Conversion (Pair) (No Threshold)	Deduct	-\$17.28
Concealed Rod Exit	ADD	N/C
Prep for Customer Supplied Hardware	ADD	Quote

Frame Options

Special Frame Height up to 8' Without Transom	ADD	\$100.00
Special Frame Height up to 10'3" With Transom	ADD	\$80.00
Special Frame Width up to 4' (Add to 3' Frame)	ADD	\$80.00

Please call for special prices on items not listed above

www.americanprod.com Email: bids@americanprod.com

Phone: 813-925-0144 Fax: 813-925-1414





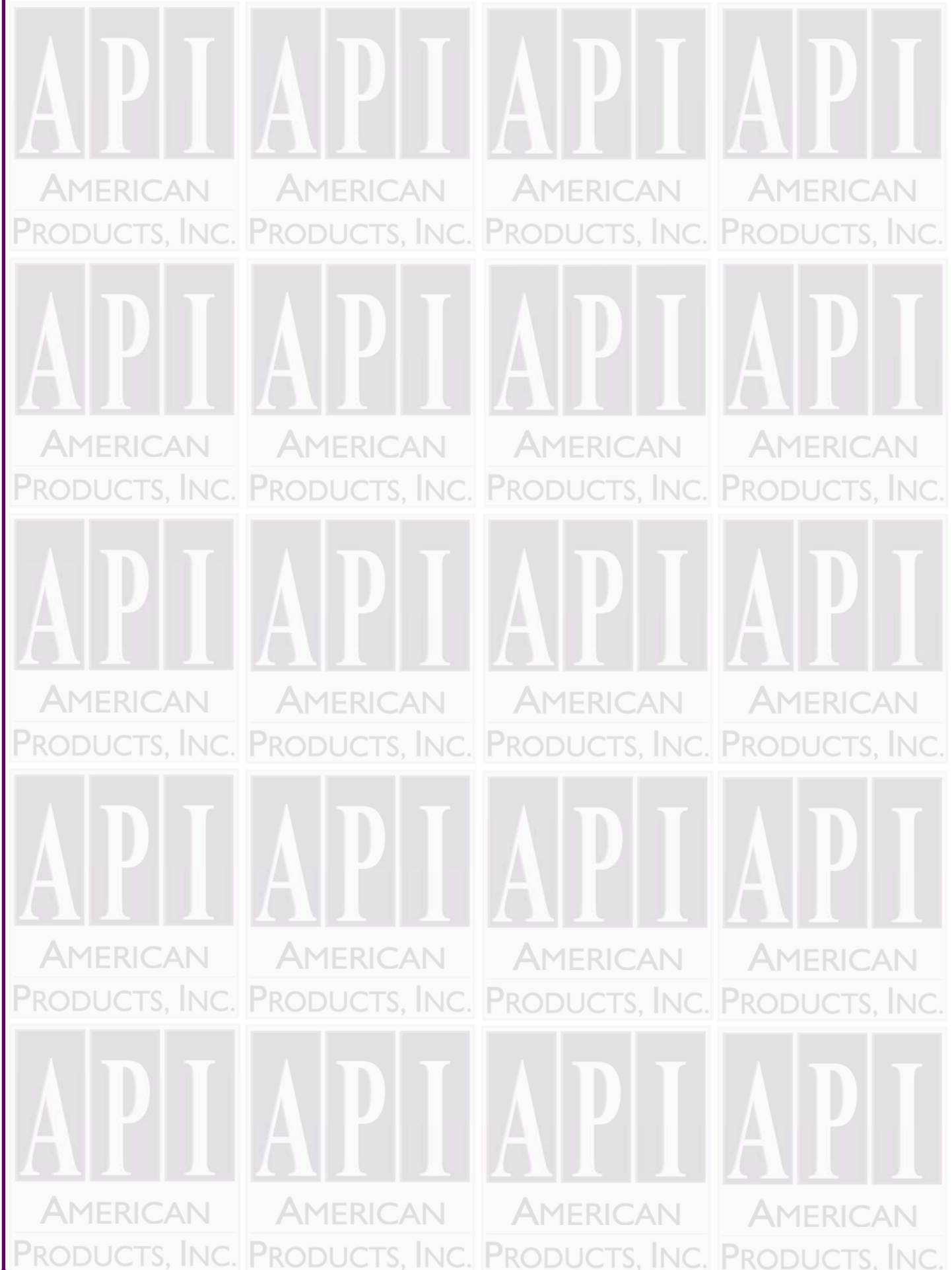





NOTES



www.americanprod.com Email: bids@americanprod.com

Fax: 813-925-1414

Phone: 813-925-0144

DOOR PARTS					
DESCRIPTION	PART NUMBER	FOOT / UNIT	UNITS / PACKAGE	FINISH	LIST PRICE / UNIT
 4" Threshold	API-1341	24'		Mill	Quote
 Open Back Jamb/Header with Stop Single Acting	API-1463	24'		Clear	Quote
				Bronze	Quote
				2-Coat Kynar	Quote
				Powder Coat	Quote
 Open Back Jamb/Header Double Acting	API-1462	24'		Clear	Quote
				Bronze	Quote
				2-Coat Kynar	Quote
				Powder Coat	Quote
 Header Shear Block	API-9301	24'		Clear	Quote
 Double Acting Jamb	API-1064	24'		Bronze	Quote
				2-Coat Kynar	Quote
 Tube Header	API-17545H	24'		Bronze	Quote
				2-Coat Kynar	Quote
 2"x 4-1/2" Open Back Tube	API-S32004	24'		Bronze	Quote
				2-Coat Kynar	Quote
 Closure Panel	API-S32005	24"		Bronze	Quote
				2-Coat Kynar	Quote

CROSS RAILS AND STILES WITHOUT STOPS

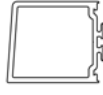





DESCRIPTION	PART NUMBER	FOOT / UNIT	UNITS / PACKAGE	FINISH	LIST PRICE / UNIT
 Radiused Narrow Stile 1-15/16"	API-1207	24'		Clear	Quote
				Bronze	Quote
				2-Coat Kynar	Quote
				Powder Coat	Quote
 Radiused Narrow Style with Astragal 1-15/16"	API-1206	24'		Clear	Quote
				Bronze	Quote
				2-Coat Kynar	Quote
				Powder Coat	Quote
 Beveled Narrow Stile 1-15/16"	API-1205	24'		Clear	Quote
				Bronze	Quote
				2-Coat Kynar	Quote
				Powder Coat	Quote
 Radiused Medium Style with Astragal 3-3/8"	API-1216	24'		Clear	Quote
				Bronze	Quote
				2-Coat Kynar	Quote
				Powder Coat	Quote
 Radiused Medium Stile 3-3/8"	API-1217	24'		Clear	Quote
				Bronze	Quote
				2-Coat Kynar	Quote
				Powder Coat	Quote
 Beveled Medium Stile 3-3/8"	API-1215	24'		Clear	Quote
				Bronze	Quote
				2-Coat Kynar	Quote
				Powder Coat	Quote
 Radiused Wide Stile 5-3/64"	API-1229	24'		Clear	Quote
				Bronze	Quote
				2-Coat Kynar	Quote
				Powder Coat	Quote
 Beveled Wide Stile 5-3/64"	API-1225	24'		Clear	Quote
				Bronze	Quote
				2-Coat Kynar	Quote
				Powder Coat	Quote
 Radiused Wide Stile With Astragal 5-3/64"	API-12XX	24'		Clear	Quote
				Bronze	Quote
				2-Coat Kynar	Quote
				Powder Coat	Quote
 Various Stiles	API-1235	24'		Clear	Quote
				Bronze	Quote
				2-Coat Kynar	Quote
				Powder Coat	Quote
 Rail Adaptor	API-1210	24'		Clear	Quote
				Bronze	Quote
				2-Coat Kynar	Quote
				Powder Coat	Quote

www.americanprod.com Email: bids@americanprod.com

Phone: 813-925-0144

Fax: 813-925-1414

TOP/BOTTOM RAILS

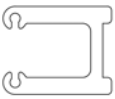
DESCRIPTION	PART NUMBER	FOOT / UNIT	UNITS / PACKAGE	FINISH	LIST PRICE / UNIT
 10" Bottom Rail	API-1223	24'		Clear	Quote
				Bronze	Quote
				2-Coat Kynar	Quote
				Powder Coat	Quote
 6-1/2" Bottom Rail	API-1222	24'		Clear	Quote
				Bronze	Quote
				2-Coat Kynar	Quote
				Powder Coat	Quote
 5" Top Rail	API-1221	24'		Clear	Quote
				Bronze	Quote
				2-Coat Kynar	Quote
				Powder Coat	Quote
 3-1/2" Bottom Rail	API-1203	24'		Clear	Quote
				Bronze	Quote
				2-Coat Kynar	Quote
				Powder Coat	Quote
 2-1/2" Top Rail	API-1201	24'		Clear	Quote
				Bronze	Quote
				2-Coat Kynar	Quote
				Powder Coat	Quote
 1/4" Glass stop	API-1243	24'		Clear	Quote
				Bronze	Quote
				2-Coat Kynar	Quote
				Powder Coat	Quote
 1" Glass Stop	API-1230	24'		Clear	Quote
				Bronze	Quote
				2-Coat Kynar	Quote
				Powder Coat	Quote
 Shear Block	API-1246	24'		Mill	Quote

www.americanprod.com Email: bids@americanprod.com

Fax: 813-925-1414



Phone: 813-925-0144



NOTES

API AMERICAN PRODUCTS, INC.	API AMERICAN PRODUCTS, INC.	API AMERICAN PRODUCTS, INC.	API AMERICAN PRODUCTS, INC.
API AMERICAN PRODUCTS, INC.	API AMERICAN PRODUCTS, INC.	API AMERICAN PRODUCTS, INC.	API AMERICAN PRODUCTS, INC.
API AMERICAN PRODUCTS, INC.	API AMERICAN PRODUCTS, INC.	API AMERICAN PRODUCTS, INC.	API AMERICAN PRODUCTS, INC.
API AMERICAN PRODUCTS, INC.	API AMERICAN PRODUCTS, INC.	API AMERICAN PRODUCTS, INC.	API AMERICAN PRODUCTS, INC.
API AMERICAN PRODUCTS, INC.	API AMERICAN PRODUCTS, INC.	API AMERICAN PRODUCTS, INC.	API AMERICAN PRODUCTS, INC.
API AMERICAN PRODUCTS, INC.	API AMERICAN PRODUCTS, INC.	API AMERICAN PRODUCTS, INC.	API AMERICAN PRODUCTS, INC.

STANDARD PUSH / PULL SETS

DESCRIPTION	PART NUMBER	UNITS/	FINISH	LIST PRICE/
 <p>1" x 10" Back to Back Push / Pull</p>	DH0005		Clear	\$98.01
			Bronze	\$111.21
			Brushed SS	\$231.99
			Polished SS	\$268.29
 <p>1" Back to Back Push Bars</p>	DH0010		Clear	\$105.60
			Bronze	\$118.80
			Brushed SS	\$290.40
			Polished SS	\$330.00
 <p>1" x 10" Back to Back Pulls</p>	DH0020		Clear	\$89.76
			Bronze	\$102.96
			Brushed SS	\$176.22
			Polished SS	\$209.22

www.americanprod.com Email: bids@americanprod.com

Phone: 813-925-0144 Fax: 813-925-1414

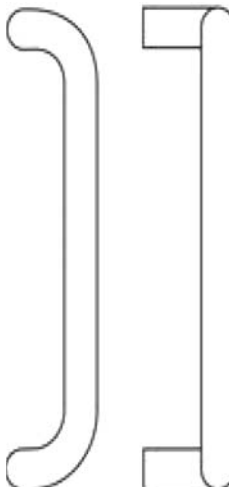
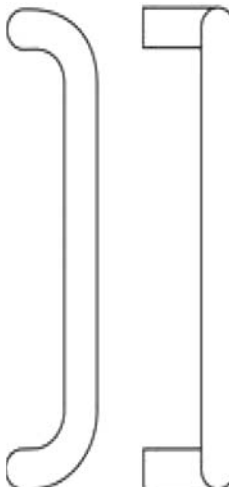
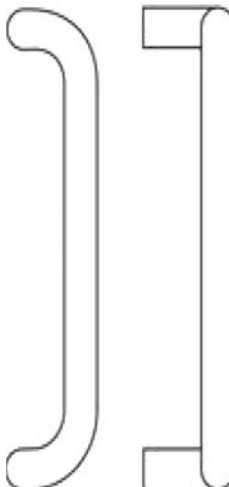

ROCKWOOD PUSH / PULL SETS

DESCRIPTION	PART NUMBER	UNITS/ PACKAGE	FINISH	LIST PRICE/ UNIT
	Rockwood #166		Clear	\$55.14
	8" Pull		Bronze	\$64.59
	45 deg.		Brushed SS	\$159.75
	1" Dia.		Polished SS	\$170.10
	Rockwood #167A		Clear	\$61.44
	9" Pull		Bronze	\$72.45
	45 deg.		Brushed SS	\$165.39
	1" Dia.		Polished SS	\$176.40
	Rockwood #167		Clear	\$61.44
	10" Pull		Bronze	\$72.45
	45 deg.		Brushed SS	\$171.69
	1" Dia.		Polished SS	\$181.14
	Rockwood #168		Clear	\$69.30
	10" Pull		Bronze	\$80.34
	45 deg.		Brushed SS	\$182.70
	1" Dia.		Polished SS	\$193.74
	Rockwood #169		Clear	\$88.20
	18" Pull		Bronze	\$99.24
	45 deg.		Brushed SS	\$220.50
	1" Dia.		Polished SS	\$228.39
	Rockwood #BF156		Clear	\$55.14
	8" Pull		Bronze	\$64.59
	90 deg.		Brushed SS	\$129.15
	1" Dia.		Polished SS	\$141.75
	Rockwood #BF157A		Clear	\$61.44
	9" Pull		Bronze	\$72.45
	90 deg.		Brushed SS	\$135.45
	1" Dia.		Polished SS	\$146.49
	Rockwood #BF157		Clear	\$61.44
	10" Pull		Bronze	\$72.45
	90 deg.		Brushed SS	\$141.75
	1" Dia.		Polished SS	\$152.79
	Rockwood #BF158		Clear	\$69.30
	10" Pull		Bronze	\$80.34
	90 deg.		Brushed SS	\$152.79
	1" Dia.		Polished SS	\$163.80
	Rockwood #BF159		Clear	\$88.20
	18" Pull		Bronze	\$99.24
	90 deg.		Brushed SS	\$189.00
	1" Dia.		Polished SS	\$200.04



www.americanprod.com Email: bids@americanprod.com

Phone: 813-925-0144

Fax: 813-925-1414

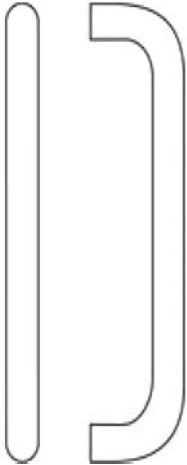

ROCKWOOD PUSH / PULL SETS

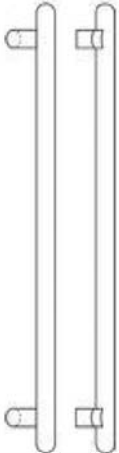
DESCRIPTION	PART NUMBER	UNITS/ PACKAGE	FINISH	LIST PRICE/ UNIT
	Rockwood #110 8" Pull Straight 1" Dia.		Clear	\$34.65
			Bronze	\$39.39
			Brass	\$94.50
			Stainless	\$102.39
	Rockwood #111A 9" Pull Straight 1" Dia.		Clear	\$36.24
			Bronze	\$40.95
			Brushed SS	\$97.65
			Polished SS	\$110.25
	Rockwood #111 10" Pull Straight 1" Dia.		Clear	\$36.24
			Bronze	\$40.95
			Brushed SS	\$107.10
			Polished SS	\$118.14
Rockwood #112 10" Pull Straight 1" Dia.			Clear	\$37.80
			Bronze	\$44.10
			Brushed SS	\$116.55
			Polished SS	\$126.00
Rockwood #118 18" Pull Straight 1" Dia.			Clear	\$50.40
			Bronze	\$58.29
			Brushed SS	\$151.20
			Polished SS	\$165.39
	Rockwood #SP47 Single Protection Push 1" Dia.		Clear	\$94.50
			Bronze	\$111.84
			Brushed SS	\$291.39
			Polished SS	\$315.00
	Rockwood #47 Push Bar 1" Dia.		Clear	\$78.75
			Bronze	\$96.09
			Brushed SS	\$267.75
			Polished SS	\$283.50
	Rockwood #RM3300 - Straight Square Ends - 1" Diameter			
	40"		Clear	\$252.00
	54"		Clear	\$362.25
	80"		Clear	\$456.75
	40"		Bronze	\$299.25
	54"		Bronze	\$409.50
	80"		Bronze	\$504.00
	40"		Brushed SS	\$504.00
	54"		Brushed SS	\$582.75
	80"		Brushed SS	\$787.50
	40"		Polished SS	\$393.75
	54"		Polished SS	\$441.00
80"		Polished SS	\$551.25	

www.americanprod.com Email: bids@americanprod.com



Phone: 813-925-0144 Fax: 813-925-1414

Phone: 813-925-0144 Fax: 813-925-1414

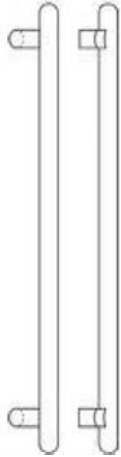
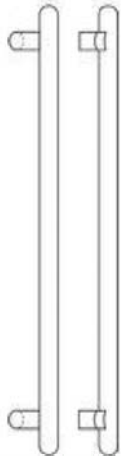
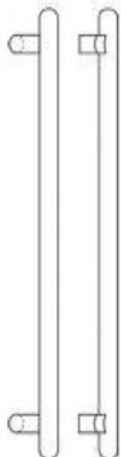

ROCKWOOD PUSH / PULL SETS				
DESCRIPTION	PART NUMBER	UNITS/ PACKAGE	FINISH	LIST PRICE/ UNIT
	Rockwood #RM3301 - Straight Square Ends - 1-1/4" Diameter			
	40"		Clear	\$299.25
	54"		Clear	\$409.50
	80"		Clear	\$551.25
	40"		Bronze	\$346.50
	54"		Bronze	\$456.75
	80"		Bronze	\$598.50
	40"		Brushed SS	\$378.00
	54"		Brushed SS	\$409.50
	80"		Brushed SS	\$504.00
	40"		Polished SS	\$409.50
	54"		Polished SS	\$441.00
80"		Polished SS	\$567.00	
	Rockwood #RM3302 - Straight Square Ends - 1-1/2" Diameter			
	40"		Clear	N/A
	54"		Clear	N/A
	80"		Clear	N/A
	40"		Bronze	N/A
	54"		Bronze	N/A
	80"		Bronze	N/A
	40"		Brushed SS	\$393.75
	54"		Brushed SS	\$441.00
	80"		Brushed SS	\$535.50
	40"		Polished SS	\$425.25
	54"		Polished SS	\$488.25
80"		Polished SS	\$630.00	
	Rockwood #RM3310 - Offset Square Ends - 1" Diameter			
	40"		Clear	N/A
	54"		Clear	N/A
	80"		Clear	N/A
	40"		Bronze	N/A
	54"		Bronze	N/A
	80"		Bronze	N/A
	40"		Brushed SS	\$401.64
	54"		Brushed SS	\$448.89
	80"		Brushed SS	\$527.64
	40"		Polished SS	\$433.14
	54"		Polished SS	\$480.39
80"		Polished SS	\$590.64	

ROCKWOOD PUSH / PULL SETS

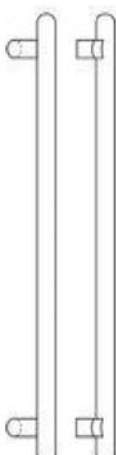
DESCRIPTION	PART NUMBER	UNITS/ PACKAGE	FINISH	LIST PRICE/ UNIT
	Rockwood #RM3311 - Straight Square Ends - 1-1/4" Diameter			
	40"		Clear	N/A
	54"		Clear	N/A
	80"		Clear	N/A
	40"		Bronze	N/A
	54"		Bronze	N/A
	80"		Bronze	N/A
	40"		Brushed SS	\$417.39
	54"		Brushed SS	\$448.89
	80"		Brushed SS	\$543.39
	40"		Polished SS	\$448.89
	54"		Polished SS	\$480.39
80"		Polished SS	\$606.39	
	Rockwood #RM3312 - Offset Square Ends - 1-1/2" Diameter			
	40"		Clear	N/A
	54"		Clear	N/A
	80"		Clear	N/A
	40"		Bronze	N/A
	54"		Bronze	N/A
	80"		Bronze	N/A
	40"		Brushed SS	\$433.14
	54"		Brushed SS	\$480.39
	80"		Brushed SS	\$574.89
	40"		Polished SS	\$464.64
	54"		Polished SS	\$527.64
80"		Polished SS	\$669.39	
	Rockwood #RM3320 - Straight Round Ends - 1" Diameter			
	40"		Clear	\$291.39
	54"		Clear	\$401.64
	80"		Clear	\$496.14
	40"		Bronze	\$338.64
	54"		Bronze	\$448.89
	80"		Bronze	\$543.39
	40"		Brushed SS	\$409.50
	54"		Brushed SS	\$456.75
	80"		Brushed SS	\$535.50
	40"		Polished SS	\$441.00
	54"		Polished SS	\$488.25
80"		Polished SS	\$598.50	



www.americanprod.com Email: bids@americanprod.com

Phone: 813-925-0144 Fax: 813-925-1414

Phone: 813-925-0144 Fax: 813-925-1414



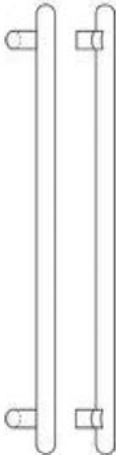
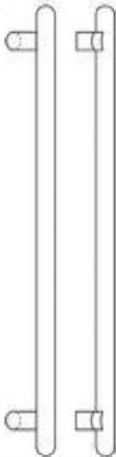

ROCKWOOD PUSH / PULL SETS

DESCRIPTION	PART NUMBER	UNITS/ PACKAGE	FINISH	LIST PRICE/ UNIT
	Rockwood #RM3321 - Straight Square Ends - 1-1/4" Diameter			
	40"		Clear	\$338.64
	54"		Clear	\$448.89
	80"		Clear	\$590.64
	40"		Bronze	\$385.95
	54"		Bronze	\$496.14
	80"		Bronze	\$637.89
	40"		Brushed SS	\$425.25
	54"		Brushed SS	\$456.75
	80"		Brushed SS	\$551.25
	40"		Polished SS	\$456.75
	54"		Polished SS	\$488.25
80"		Polished SS	\$614.25	
	Rockwood #RM3322 - Straight Round Ends - 1-1/2" Diameter			
	40"		Clear	N/A
	54"		Clear	N/A
	80"		Clear	N/A
	40"		Bronze	N/A
	54"		Bronze	N/A
	80"		Bronze	N/A
	40"		Brushed SS	\$456.75
	54"		Brushed SS	\$504.00
	80"		Brushed SS	\$598.50
	40"		Polished SS	\$488.25
	54"		Polished SS	\$551.25
80"		Polished SS	\$693.00	
	Rockwood #RM3330 - Offset Round Ends - 1" Diameter			
	40"		Clear	N/A
	54"		Clear	N/A
	80"		Clear	N/A
	40"		Bronze	N/A
	54"		Bronze	N/A
	80"		Bronze	N/A
	40"		Brushed SS	\$448.89
	54"		Brushed SS	\$496.14
	80"		Brushed SS	\$574.89
	40"		Polished SS	\$480.39
	54"		Polished SS	\$527.64
80"		Polished SS	\$637.89	



ROCKWOOD PUSH / PULL SETS

DESCRIPTION	PART NUMBER	UNITS/ PACKAGE	FINISH	LIST PRICE/ UNIT
	Rockwood #RM3331 - Offset Round Ends - 1-1/4" Diameter			
	40"		Clear	N/A
	54"		Clear	N/A
	80"		Clear	N/A
	40"		Bronze	N/A
	54"		Bronze	N/A
	80"		Bronze	N/A
	40"		Brushed SS	\$464.64
	54"		Brushed SS	\$496.14
	80"		Brushed SS	\$590.64
	40"		Polished SS	\$496.14
	54"		Polished SS	\$527.64
80"		Polished SS	\$563.64	
	Rockwood #RM3332 - Offset Round Ends - 1-1/2" Diameter			
	40"		Clear	N/A
	54"		Clear	N/A
	80"		Clear	N/A
	40"		Bronze	N/A
	54"		Bronze	N/A
	80"		Bronze	N/A
	40"		Brushed SS	\$496.14
	54"		Brushed SS	\$543.39
	80"		Brushed SS	\$637.89
	40"		Polished SS	\$527.64
	54"		Polished SS	\$590.64
80"		Polished SS	\$732.39	
	Rockwood #RM3340 - Straight Bent Ends - 1" Diameter			
	40"		Clear	\$220.50
	54"		Clear	\$488.25
	80"		Clear	\$519.75
	40"		Bronze	\$267.75
	54"		Bronze	\$535.50
	80"		Bronze	\$567.00
	40"		Brushed SS	\$346.50
	54"		Brushed SS	\$393.75
	80"		Brushed SS	\$488.25
	40"		Polished SS	\$378.00
	54"		Polished SS	\$425.25
80"		Polished SS	\$550.50	

www.americanprod.com Email: bids@americanprod.com

Phone: 813-925-0144 Fax: 813-925-1414

Phone: 813-925-0144 Fax: 813-925-1414

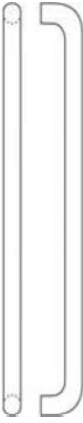
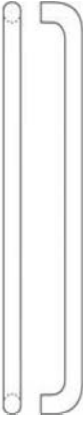

ROCKWOOD PUSH / PULL SETS

DESCRIPTION	PART NUMBER	UNITS/ PACKAGE	FINISH	LIST PRICE/ UNIT
	Rockwood #RM3341 - Straight Bent Ends - 1-1/4" Diameter			
	40"		Clear	\$299.25
	54"		Clear	\$441.00
	80"		Clear	\$567.00
	40"		Bronze	\$330.75
	54"		Bronze	\$488.25
	80"		Bronze	\$630.00
	40"		Brushed SS	\$362.25
	54"		Brushed SS	\$409.50
	80"		Brushed SS	\$504.00
	40"		Polished SS	\$393.75
	54"		Polished SS	\$441.00
80"		Polished SS	\$567.00	
	Rockwood #RM3342 - Straight Bent Ends - 1-1/2" Diameter			
	40"		Clear	N/A
	54"		Clear	N/A
	80"		Clear	N/A
	40"		Bronze	N/A
	54"		Bronze	N/A
	80"		Bronze	N/A
	40"		Brushed SS	\$409.50
	54"		Brushed SS	\$441.00
	80"		Brushed SS	\$535.50
	40"		Polished SS	\$441.00
	54"		Polished SS	\$488.25
80"		Polished SS	\$630.00	

www.americanprod.com Email: bids@americanprod.com

Phone: 813-925-0144

Fax: 813-925-1414



CUSTOM ENTRANCES AND HARDWARE

MORE DETAILS COMING SOON!

CALL FOR PRICING AT 813-925-0144

FAX AT 813-925-1414

OR EMAIL BID TO bids@americanprod.com

www.americanprod.com Email: bids@americanprod.com

Fax: 813-925-1414

Phone: 813-925-0144



NOTES

API AMERICAN PRODUCTS, INC.	API AMERICAN PRODUCTS, INC.	API AMERICAN PRODUCTS, INC.	API AMERICAN PRODUCTS, INC.
API AMERICAN PRODUCTS, INC.	API AMERICAN PRODUCTS, INC.	API AMERICAN PRODUCTS, INC.	API AMERICAN PRODUCTS, INC.
API AMERICAN PRODUCTS, INC.	API AMERICAN PRODUCTS, INC.	API AMERICAN PRODUCTS, INC.	API AMERICAN PRODUCTS, INC.
API AMERICAN PRODUCTS, INC.	API AMERICAN PRODUCTS, INC.	API AMERICAN PRODUCTS, INC.	API AMERICAN PRODUCTS, INC.
API AMERICAN PRODUCTS, INC.	API AMERICAN PRODUCTS, INC.	API AMERICAN PRODUCTS, INC.	API AMERICAN PRODUCTS, INC.
API AMERICAN PRODUCTS, INC.	API AMERICAN PRODUCTS, INC.	API AMERICAN PRODUCTS, INC.	API AMERICAN PRODUCTS, INC.

www.americanprod.com Email: bids@americanprod.com

Phone: 813-925-0144 Fax: 813-925-1414

CONCEALED CLOSERS

Dorma BTS80 Concealed Floor Closer

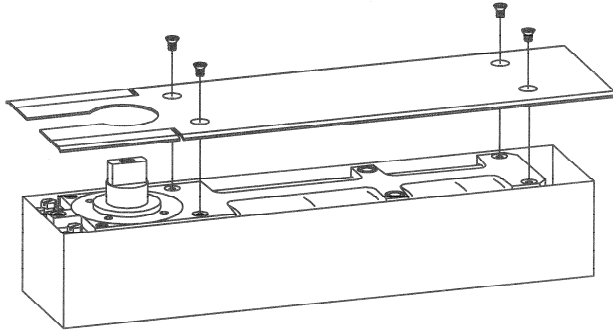

Hold Open	Part #	Finish	Price
No		Light	\$797.85
Yes		Light	\$797.85
No		Medium	\$797.85
Yes		Medium	\$797.85
No		Heavy	\$797.85
Yes		Heavy	\$797.85

BTS80 Cover Plate

Part #	Finish	Price
	Clear	\$95.85
	Bronze	\$95.85

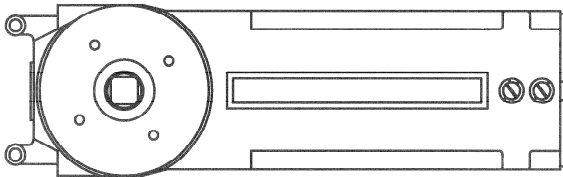

Dorma RTS88 Concealed Overhead Closer



Hold Open	Part #	Finish	Price
No		Light	\$294.30
Yes		Light	\$294.30
No		Medium	\$294.30
Yes		Medium	\$294.30
No		Heavy	\$294.30
Yes		Heavy	\$294.30

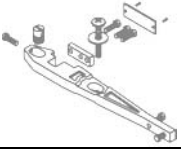
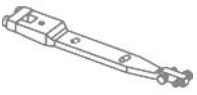

ACCESSORIES FOR CONCEALED CLOSERS

DESCRIPTION	PART NUMBER	UNITS/ PACKAGE	LIST PRICE/ UNIT
 <p>Side Load Center Pivot Arm for Center Pivot Doors</p>	DP0005		\$52.65
 <p>End Load Center Pivot Arm for Center Pivot Doors</p>	DP0010		\$66.15
 <p>Offset Closer Arm Assembly</p>	DP0015		\$89.10

www.americanprod.com Email: bids@americanprod.com

Phone: 813-925-0144

Fax: 813-925-1414



www.americanprod.com Email: bids@americanprod.com

Fax: 813-925-1414

Phone: 813-925-0144

SURFACE MOUNTED CLOSERS

**Dor-O-Matic SC60 Surface Closer
(For Offset Pivot and Butt Hinge Doors)**



Hold Open	Part #	Finish	Price
No		Clear	\$189.00
No		Bronze	\$189.00
Yes		Clear	\$205.62
Yes		Bronze	\$205.62

**LCN 4040 Surface Closer
(For Offset Pivot and Butt Hinge Doors)**

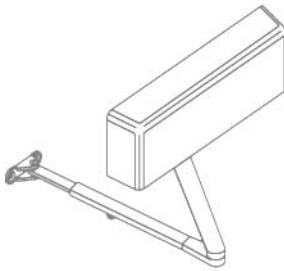

Hold Open	Part #	Finish	Price
No		Clear	\$821.04
No		Bronze	\$821.04
Yes		Clear	\$887.55
Yes		Bronze	\$887.55

	Part #	Finish	Price
Frame Adaptor		Clear	\$105.30
		Bronze	\$105.30
Transom Adaptor		Clear	\$105.30
		Bronze	\$105.30
Medium and Wide Stile Adaptor Without Transom		Clear	\$105.30
		Bronze	\$105.30

SURFACE MOUNTED NORTON CLOSERS

**Norton 1601 Adjustable Surface Closer
(For Offset Pivot and Butt Hinge Doors)**



Hold Open	Part #	Finish	Price
No		Clear	\$235.17
No		Bronze	\$235.17
Yes		Clear	\$250.44
Yes		Bronze	\$250.44

**Norton 8101 Adjustable Surface Closer
(For Offset Pivot and Butt Hinge Doors)**

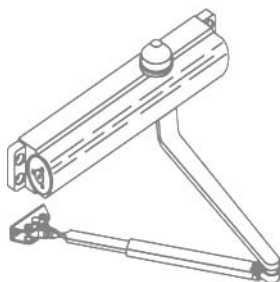

Hold Open	Part #	Finish	Price
No		Clear	\$264.18
No		Bronze	\$264.18
Yes		Clear	\$306.93
Yes		Bronze	\$306.93













Norton 8101 Cover

Part #	Finish	Price
	Clear	\$24.42
	Bronze	\$24.42

www.americanprod.com Email: bids@americanprod.com

Phone: 813-925-0144 Fax: 813-925-1414



ACCESSORIES FOR CLOSERS			
DESCRIPTION	PART NUMBER	FINISH	LIST PRICE/ UNIT
 <p>Drop Plate</p>	1601	Clear	\$39.30
	1601	Bronze	\$39.30
	8101	Clear	\$39.30
	8101	Bronze	\$39.30
 <p>Adaptor Plate for Parallel Arms</p>	1601	Clear	\$43.86
	1601	Bronze	\$43.86
	8101	Clear	\$43.86
	8101	Bronze	\$43.86
 <p>Parallel Arm Soffit Plate</p>	ALL	Clear	\$21.18
	ALL	Bronze	\$21.18
 <p>Parallel Arm Soffit Plate Hold Open</p>	ALL	Clear	\$21.18
	ALL	Bronze	\$21.18
 <p>No Hold Open Arm Regular Length</p>	ALL	Clear	\$68.04
	ALL	Bronze	\$68.04
 <p>No Hold Open Arm Extra Length 5" to 7-1/2"</p>	ALL	Clear	\$75.60
	ALL	Bronze	\$75.60
 <p>No Hold Open Arm Extra Length 7-1/2" to 9-1/2"</p>	ALL	Clear	\$86.19
	ALL	Bronze	\$86.19
 <p>Hold Open Arm Regular Length</p>	ALL	Clear	\$108.87
	ALL	Bronze	\$108.87
 <p>Hold Open Arm Extra Length 5" to 7-1/2"</p>	ALL	Clear	\$114.90
	ALL	Bronze	\$114.90
 <p>Hold Open Arm Extra Length 7-1/2" to 9-1/2"</p>	ALL	Clear	\$125.49
	ALL	Bronze	\$125.49

www.americanprod.com Email: bids@americanprod.com

Fax: 813-925-1414

Phone: 813-925-0144



NOTES

API

AMERICAN
PRODUCTS, INC.

API

AMERICAN
PRODUCTS, INC.

API

AMERICAN
PRODUCTS, INC.

API

AMERICAN
PRODUCTS, INC.

API

AMERICAN
PRODUCTS, INC.

API

AMERICAN
PRODUCTS, INC.

API

AMERICAN
PRODUCTS, INC.

API

AMERICAN
PRODUCTS, INC.

API

AMERICAN
PRODUCTS, INC.

API

AMERICAN
PRODUCTS, INC.

API

AMERICAN
PRODUCTS, INC.

API

AMERICAN
PRODUCTS, INC.

API

AMERICAN
PRODUCTS, INC.

API

AMERICAN
PRODUCTS, INC.

API

AMERICAN
PRODUCTS, INC.

API

AMERICAN
PRODUCTS, INC.

API

AMERICAN
PRODUCTS, INC.

API

AMERICAN
PRODUCTS, INC.

API

AMERICAN
PRODUCTS, INC.

API

AMERICAN
PRODUCTS, INC.

GLASS DOORS

API's Swinging Glass Doors are an ideal way to add style and elegance to any interior or exterior location. Available in a wide array of different patterns, our Swinging Glass Doors provide you with virtually unlimited design possibilities.

API's Sliding Glass Doors are designed for entrances that must be kept open during business hours, while conserving valuable floor space. To suit any environment, both bi-parting and stacking Sliding Glass Doors are available.

API's Glass Door Hardware is offered in many exciting anodized and powder coat colors and finishes, in addition to stainless steel and brass, providing you with unique opportunities to incorporate your color palette and design throughout your entire storefront.

Use door hardware in colors that match adjoining sidelite rails to create continuity throughout your design. Or, apply a variety of color combinations to your hardware to liven up any entryway.

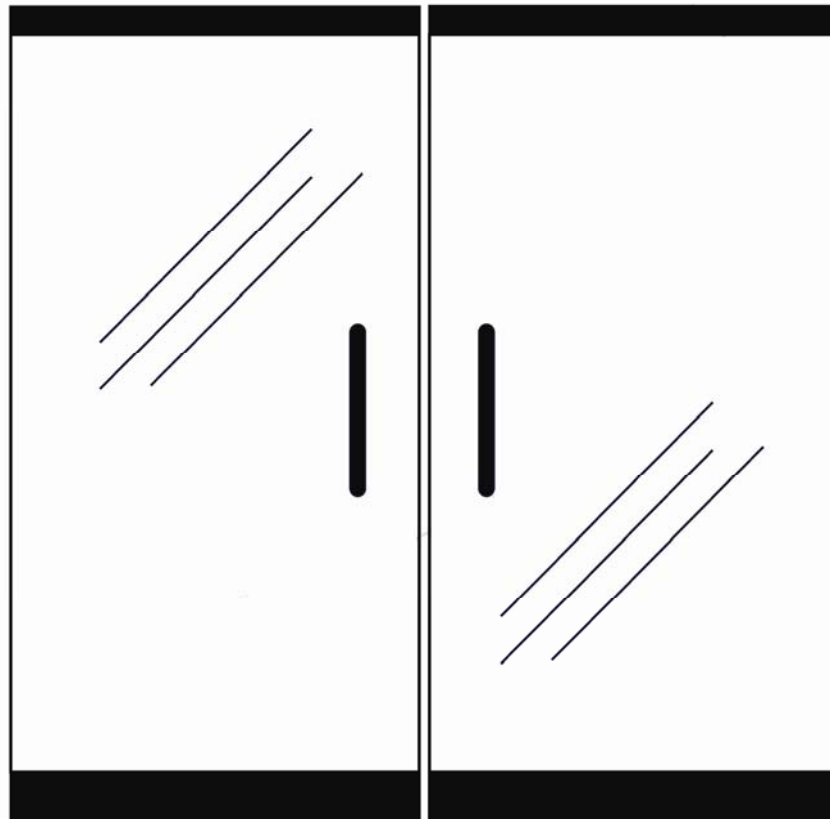

www.americanprod.com Email: bids@americanprod.com

Phone: 813-925-0144 Fax: 813-925-1414

SWINGING GLASS DOOR

6" Bottom Rail
Top Patch

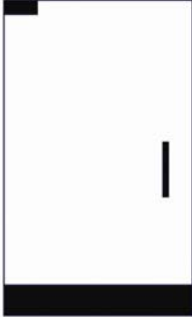

6" Bottom Rail
6" Top Patch



6" Bottom Rail
4" Top Patch



10" Bottom Rail
Top Patch

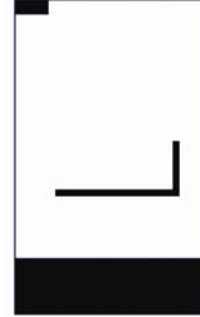

4" Bottom Rail
Top Patch

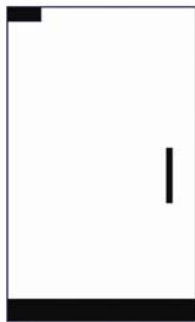

4" Bottom Rail
4" Top Patch

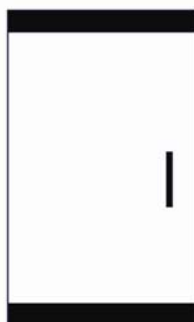

Bottom Patch



10" Bottom Rail
Top Patch

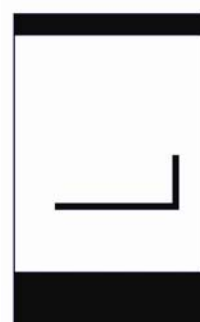

SWINGING GLASS DOOR

Sliding Glass Door Bi-Parting

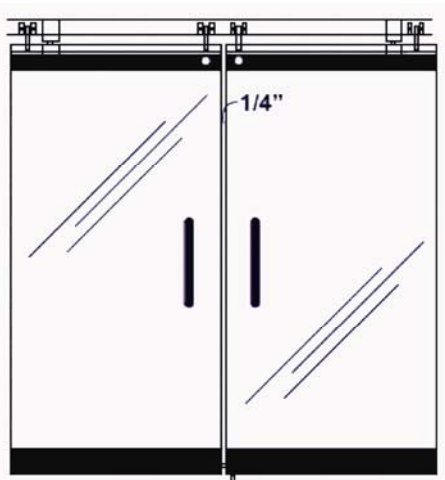

Sliding Glass Door Stacking

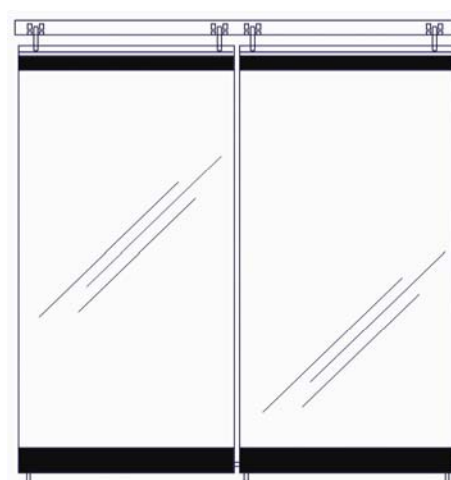

www.americanprod.com Email: bids@americanprod.com

Phone: 813-925-0144 Fax: 813-925-1414